

MINIMALLY SUPPORTED FREQUENCY COMPOSITE DILATION WAVELETS

Jeffrey D. Blanchard

Department of Mathematics, University of Utah, Salt Lake City, UT 84112

November 2007, Revised May 2008

ABSTRACT. A composite dilation wavelet is a collection of functions generating an orthonormal basis for $L^2(\mathbb{R}^n)$ under the actions of translations from a full rank lattice and dilations by products of elements of non-commuting groups A and B . A minimally supported frequency composite dilation wavelet has generating functions whose Fourier transforms are characteristic functions of a lattice tiling set. In this paper, we study the case where A is the group of integer powers of some expanding matrix while B is a finite subgroup of the invertible $n \times n$ matrices. This paper establishes that with any finite group B together with almost any full rank lattice, one can generate a minimally supported frequency composite dilation wavelet system. The paper proceeds by demonstrating the ability to find such minimally supported frequency composite dilation wavelets with a single generator.

2000 Mathematics Subject Classification: Primary 42C15, 42C40; Secondary 20F55, 51F15

Keywords and phrases: affine systems, composite dilation wavelets, Coxeter groups, minimally supported frequency, multiwavelets, reflection groups, wavelet sets, wavelets

1 Introduction

Recently a new class of representation systems called *Affine Systems with Composite Dilations* [11, 12, 13] was introduced in response to the growing interest in oriented oscillatory waveforms used in mathematics and its applications. Examples of oriented oscillatory waveforms are *brushlets* [20], *contourlets* [6], *curvelets* [3], *ridglets* [2], and *shearlets* [9]. Of these, only shearlets are examples of affine systems with composite dilations. For shearlets, one uses dilations by a group of shear matrices together with powers of an expanding matrix. In this paper, we will construct orthonormal composite wavelet systems with an arbitrary finite group. Like the most basic shearlets [17], these wavelets will be of the MSF (minimally supported frequency) type; i.e. their Fourier transforms are characteristic functions.

The theory of composite dilation wavelets already has many interesting results including simple Haar-type bases in the time domain [16] and the development of shearlets [9], [10], [17]. One of the noteworthy advantages of composite dilation systems is the natural extension of a multiresolution analysis (MRA) [13] (recalled here in Section 1.2). Section 2 consists of constructive proofs establishing the main result:

Theorem 1. *If B is a finite group of invertible $n \times n$ matrices then there exists a Multiresolution Analysis, Minimally Supported Frequency, Composite Dilation Wavelet for $L^2(\mathbb{R}^n)$.*

In Section 3, we show that making wise choices can produce MSF composite dilation wavelets with a single wavelet generator. Here we see that composite dilation wavelet systems can significantly reduce the input requirements for potential implementations by transferring the need for multiple wavelet generators to the composite dilation group.

We study MSF composite dilation wavelets to provide useful insights into the theory of composite wavelets, but note that they have poor time localization and must be smoothed in order to be useful in applications. The shearlets are obtained by smoothing MSF shearlets to form Parseval frames with improved time localization. This paper establishes a foundation for potentially developing similar directional representation systems using finite groups and full rank lattices. From the constructive proofs leading to Theorem 3, we can closely approximate the frequency domain geometry of a signal by choosing our groups and lattices appropriately. In the spirit of curvelets and shearlets, Section 4 discusses the construction of long, narrow windows with essentially any orientation.

1.1 Composite Dilation Wavelets

A linear transformation of the integer lattice is a *full rank lattice*, $\Gamma = c\mathbb{Z}^n$ for $c \in GL_n(\mathbb{R})$, the space of invertible $n \times n$ matrices. A *lattice basis* for $\Gamma = c\mathbb{Z}^n$ is a set $\{\gamma_i\}_{i=1}^n$ such that every element of the lattice, $\gamma \in \Gamma$, can be uniquely written as an integer combination of the basis elements: $\gamma = \sum_{i=1}^n m_i \gamma_i$ where $m_i \in \mathbb{Z}$. Notice that if c_i is the i th column of the matrix c , then the set $\{c_i\}_{i=1}^n$ is a lattice basis for Γ .

For any $k \in \Gamma$, the *translation of f by k* , T_k , acts on a function f in $L^2(\mathbb{R}^n)$ by $T_k f(x) = f(x - k)$. When $a \in GL_n(\mathbb{R})$, the *dilation of f by a* is the operator $D_a f(x) = |\det(a)|^{-\frac{1}{2}} f(a^{-1}x)$. These two unitary operators are applied to a set of generating functions to develop an affine system.

For a countable subset of invertible matrices $C \subset GL_n(\mathbb{R})$, Γ a full rank lattice, and $\psi^1, \dots, \psi^L \in L^2(\mathbb{R}^n)$, the *affine system produced by C , Γ , and $\Psi = (\psi^1, \dots, \psi^L)$* is the set $\mathcal{A}_{C\Gamma}(\Psi) = \{D_c T_k \psi^l : c \in C, k \in \Gamma, 1 \leq l \leq L\}$. As introduced by Guo, Labate, Lim, Weiss, and Wilson [11, 12, 13] affine systems with composite dilations,

$$\mathcal{A}_{AB\Gamma}(\Psi) = \left\{ D_a D_b T_k \psi^l : a \in A, b \in B, k \in \Gamma, 1 \leq l \leq L \right\}, \quad (1)$$

are obtained when $C = AB$ is the product of two not necessarily commuting subsets of invertible matrices. In this discussion, $A = \{a^j : j \in \mathbb{Z}\}$ for an expanding matrix $a \in GL_n(\mathbb{R})$ while B is a finite subgroup of $GL_n(\mathbb{R})$.

Definition 1. $\Psi = (\psi^1, \dots, \psi^L) \subset L^2(\mathbb{R}^n)$ is a *Composite Dilation Wavelet* if there exist A , B , and Γ such that $\mathcal{A}_{AB\Gamma}(\Psi)$ is an orthonormal basis for $L^2(\mathbb{R}^n)$.

These systems are a generalization of the traditional wavelet systems. When $a = 2$, $B = \{I\}$, $\Gamma = \mathbb{Z}$, and $L = 1$ we see that (1) becomes the familiar wavelet system $\left\{ D_2^j T_k \psi : j, k \in \mathbb{Z} \right\} = \left\{ 2^{-\frac{j}{2}} \psi(2^{-j}x - k) : j, k \in \mathbb{Z} \right\}$.

A natural extension of an MSF wavelet [15], we say $\Psi = (\psi^1, \dots, \psi^L) \subset L^2(\mathbb{R}^n)$ is a *Minimally Supported Frequency Composite Dilation Wavelet* if Ψ is a composite dilation wavelet and there exist disjoint sets $R_1, \dots, R_L \subset \hat{\mathbb{R}}^n$ such that $\hat{\psi}^l = |\det(c)|^{\frac{1}{2}} \chi_{R_l}$ for all $l = 1, \dots, L$. With $\Gamma = c\mathbb{Z}^n$, each set R_l must satisfy $m(R_l) = |\det(c)|^{-1} = |\det(c^{-1})|$.

We adopt the notation that the time domain is represented by \mathbb{R}^n , and its elements will be column vectors denoted by letters of the Roman alphabet, $x = (x_1, \dots, x_n)^t \in \mathbb{R}^n$. The elements of the frequency domain, $\hat{\mathbb{R}}^n$, will be row vectors, $\xi = (\xi_1, \dots, \xi_n) \in \hat{\mathbb{R}}^n$, denoted

by letters of the Greek alphabet. We use the Fourier transform $\hat{f}(\xi) = \int_{\mathbb{R}^n} f(x)e^{-2\pi i\xi x} dx$. The inverse Fourier transform of $g \in L^2(\hat{\mathbb{R}}^n)$ is \check{g} .

The full rank lattice $\Gamma^* = \hat{\mathbb{Z}}^n c^{-1}$ is the *dual lattice* to $\Gamma = c\mathbb{Z}^n$. The rows of the matrix c^{-1} form a basis for the dual lattice Γ^* . The notion of a dual lattice is useful when defining bases for subspaces of $L^2(\mathbb{R}^n)$.

1.2 Composite Dilation Multiresolution Analysis

One classical method for constructing orthonormal wavelets is the well known multiresolution analysis. Guo et al. extend the classical MRA to affine systems with composite dilations [13]. Here we tailor the definition to our setting.

Definition 2. Let $a \in GL_n(\mathbb{R})$ be an expanding matrix, $B \subset GL_n(\mathbb{R})$ a finite group, and Γ a full rank lattice. An *AB Γ multiresolution analysis (MRA)* is a sequence, $\{V_j\}_{j \in \mathbb{Z}}$, of closed subspaces of $L^2(\mathbb{R}^n)$ satisfying

- (i) $D_b T_k V_0 = V_0$, for any $b \in B, k \in \Gamma$;
- (ii) for each $j \in \mathbb{Z}, V_j \subset V_{j+1}$ where $V_j = D_a^{-j} V_0$;
- (iii) $\bigcap_{j \in \mathbb{Z}} V_j = \{0\}$ and $\overline{\bigcup_{j \in \mathbb{Z}} V_j} = L^2(\mathbb{R}^n)$;
- (iv) $\exists \varphi \in V_0$ such that $\{D_b T_k \varphi : b \in B, k \in \Gamma\}$ is an orthonormal basis for V_0 .

Notice that in this setting, the scaling space V_0 has an orthonormal basis generated by both dilations from the finite group B and translations from the lattice Γ .

1.3 Group Actions on \mathbb{R}^n

The expression $Q_1 \cap Q_2 = \emptyset$ and the term *disjoint* are meant in the sense of measure.

We say a set Q is *bounded by a collection of hyperplanes* $\{H_1, \dots, H_s\}$ when Q is the nonempty intersection of the half-spaces defined by the collection $\{H_1, \dots, H_s\}$.

Definition 3. Let G be a group acting from the right on a measurable set $\Omega \subset \hat{\mathbb{R}}^n$. Then a *G-tiling set* for Ω is a measurable set R such that

- (i) $\bigcup_{g \in G} Rg = \Omega$ and
- (ii) $Rg_1 \cap Rg_2 = \emptyset$ for $g_1 \neq g_2 \in G$.

A set $F \subset \hat{\mathbb{R}}^n$ is a *fundamental region* for B if F is B -tiling set for $\hat{\mathbb{R}}^n$.

This distinguishes the fundamental regions of B from other tiling sets. In the following we deal with convex fundamental regions. For a nonconvex fundamental region, one may use the following constructions on a convex fundamental region and subsequently transfer the appropriate subsets to the associated portion of the nonconvex fundamental region.

Example 1. Let $B = D_4$, the group of symmetries of the square acting on $\hat{\mathbb{R}}^2$; so B is the group generated by two reflections, r_1 , the reflection through $\xi_2 = \xi_1$ and, r_2 , the reflection through the line $\xi_2 = 0$. Let $F = \{(\xi_1, \xi_2) : \xi_2 \leq \xi_1\} \cap \{(\xi_1, \xi_2) : \xi_2 \geq 0\}$. Then F is bounded by the hyperplanes $H_1 = \{(\xi_1, \xi_2) : \xi_2 = \xi_1\}$ and $H_2 = \{(\xi_1, \xi_2) : \xi_2 = 0\}$. If we let B act on F , we see that F is a fundamental region for B . See the left portion of Figure 1.

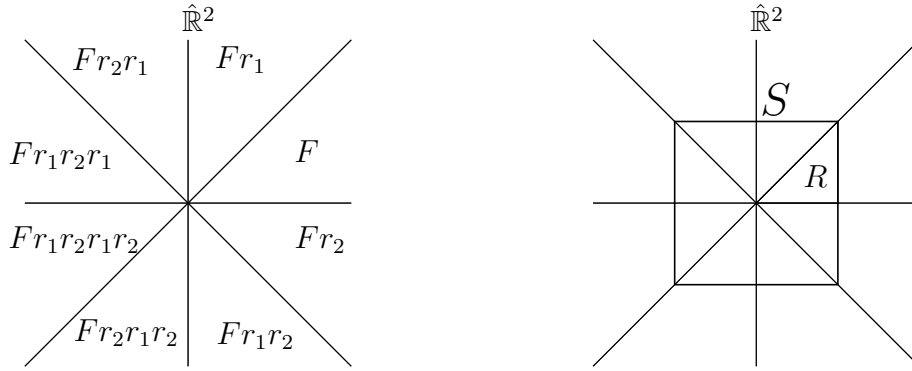

Figure 1: Let B be generated by the reflections through $\xi_2 = \xi_1$ and $\xi_2 = 0$. F is a fundamental region for B (left) and R is a B -tiling set for S (right).

Now let S be the unit square centered at the origin, $S = \{(\xi_1, \xi_2) : -\frac{1}{2} \leq \xi_1, \xi_2 \leq \frac{1}{2}\}$. Let R be the triangle with vertices $(0, 0)$, $(\frac{1}{2}, 0)$, and $(\frac{1}{2}, \frac{1}{2})$. When B acts on R , we see that R is a B -tiling set for S . See the right portion of Figure 1.

2 Existence of Minimally Supported Frequency Composite Dilation Wavelets

This section provides constructive proofs for Theorem 1 and is organized in the following manner. Section 2.1 details two admissibility conditions that define the properties required of the scaling sets and the wavelet sets, i.e. the sets supporting the Fourier transform of the scaling function and the wavelets. Section 2.2 is the heart of the paper with three core results. Theorem 5 describes how one constructs the scaling sets using any finite group of invertible matrices. Theorem 11 details the construction of the wavelet sets using the expanding matrix $a = 2I_n$. These two theorems prove Theorem 3, a more general version of the main result.

2.1 Admissibility Conditions

This section develops sufficient conditions on B , Γ , and a to admit minimally supported frequency composite dilation wavelets. The first condition describes when B and Γ will provide the appropriate scaling sets. A *Starlike Neighborhood of η* is a set S containing an open neighborhood of η and containing the line segment joining η and ξ for every $\xi \in S$.

Definition 4. Let B be a finite subgroup of $GL_n(\mathbb{R})$ and $\Gamma = c\mathbb{Z}^n$ a full rank lattice. Then Γ is *B -admissible* if there exists a measurable set $R \subset \hat{\mathbb{R}}^n$ such that:

- (i) R is a Γ^* -tiling set for $\hat{\mathbb{R}}^n$ and
- (ii) R is a B -tiling set for a starlike neighborhood of the origin, S .

When R is a Γ^* -tiling set for $\hat{\mathbb{R}}^n$, we can generate an orthonormal basis for $L^2(\Gamma)$ by using modulations associated with the lattice Γ . The duality of the lattices makes this system orthonormal. The starlike neighborhood of the origin allows the construction of

the wavelet sets with a suitable expanding matrix. The second admissibility condition determines when an expanding matrix will provide appropriate sets to support the Fourier transform of the wavelet generating functions.

Definition 5. Let Γ be B -admissible and let S be a starlike neighborhood of the origin satisfying (ii) from Definition 4. A matrix $a \in GL_n(\mathbb{R})$ is (B, Γ) -admissible if a is expanding with $S \subset Sa$ and there exist disjoint sets $R_1, \dots, R_L \subset Sa \setminus S$ such that:

- (i) for each $l = 1, \dots, L$, R_l is a Γ^* -tiling set for $\hat{\mathbb{R}}^n$ and
- (ii) $\bigcup_{l=1}^L R_l$ is a B -tiling set for $Sa \setminus S$.

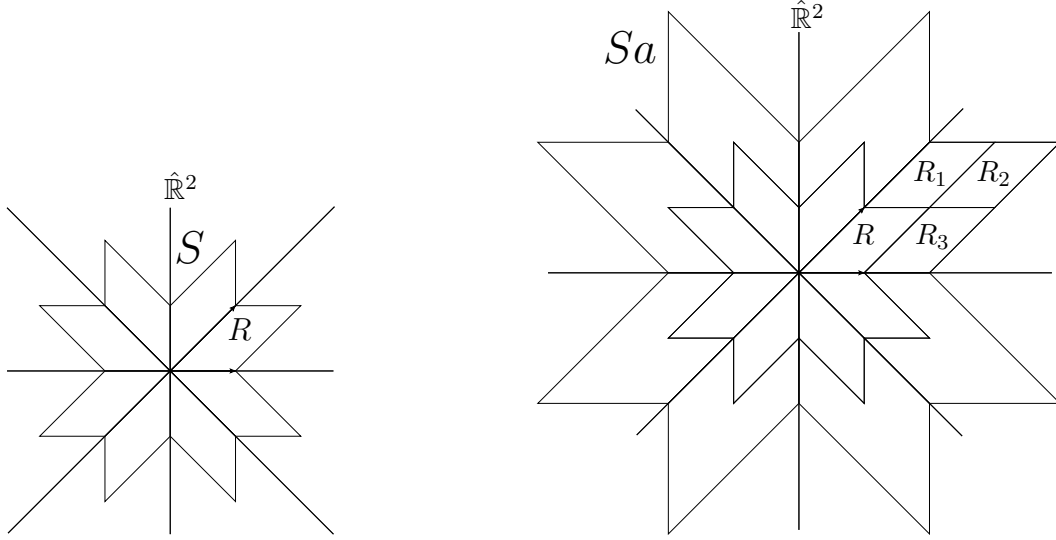

Figure 2: R is a Γ^* -tiling set and a B -tiling set for S (left). R_1, R_2, R_3 are Γ^* -tiling sets for $\hat{\mathbb{R}}^2$ and $R_1 \cup R_2 \cup R_3$ is a B -tiling set for $Sa \setminus S$ (right).

Example 2. Again, let $B = D_4$. Let $\Gamma = \begin{pmatrix} 1 & 0 \\ -1 & 1 \end{pmatrix} \mathbb{Z}^2$. Then the left portion of Figure 2 shows a set R that satisfies (i) and (ii) from Definition 4. The set S in this portion of Figure 2 is a starlike neighborhood of the origin. The right hand portion of Figure 2 shows that $a = 2(I_2)$ is (B, Γ) -admissible. We see that R_1, R_2 , and R_3 are Γ^* -tiling sets for $\hat{\mathbb{R}}^2$ and that $R_1 \cup R_2 \cup R_3$ is a B -tiling set for $Sa \setminus S$. The scaling function φ is defined by $\hat{\varphi} = \chi_R$, while the wavelets, ψ^l , are defined by $\hat{\psi}^l = \chi_{R_l}$ for $l = 1, 2, 3$.

These two admissibility conditions are sufficient for the existence of MSF, MRA composite dilation wavelets. The following is a straightforward adaptation of Proposition 3 from [13].

Theorem 2. Suppose $\Gamma = c\mathbb{Z}^n$ is a B -admissible lattice and $a \in GL_n(\mathbb{R})$ is (B, Γ) -admissible. For R_1, \dots, R_L (as in Definition 5 (i) and (ii)), let $\psi^l = |\det(c)|^{\frac{1}{2}} \chi_{R_l}$ for $1 \leq l \leq L$. Then $\Psi = (\psi^1, \dots, \psi^L)$ is an MRA, composite dilation wavelet.

2.2 Existence of MSF Composite Dilation Wavelets in $L^2(\mathbb{R}^n)$.

This section establishes Theorem 1 while using almost any full rank lattice. By *almost any full rank lattice*, we mean the matrices $c \in GL_n(\mathbb{R})$ that define B -admissible lattices $\Gamma = c\mathbb{Z}^n$ form a set of full measure in $GL_n(\mathbb{R})$. We will see in Theorem 5 that any lattice with a basis element in the interior of a fundamental region for B is B -admissible. Thus, if Γ is not B -admissible, it must be that every element of every basis of Γ^* is contained in the hyperplanes bounding a fundamental region for B . After selecting B , the set of $c \in GL_n(\mathbb{R})$ defining such lattices is a set of measure zero. Proposition 10 further reduces the size of the set of lattices that are not necessarily B -admissible.

Theorem 3. *If B is a finite subgroup of $GL_n(\mathbb{R})$ and $\Gamma = c\mathbb{Z}^n$ is almost any full rank lattice, then there exists a Multiresolution Analysis, Minimally Supported Frequency, Composite Dilation Wavelet for $L^2(\mathbb{R}^n)$.*

We first establish that every finite group acting on \mathbb{R}^n admits almost any lattice. We recall the fact that every finite subgroup of $GL_n(\mathbb{R})$ has a fundamental region bounded by hyperplanes through the origin.

Lemma 4. *Every finite subgroup of $GL_n(\mathbb{R})$ has a fundamental region bounded by hyperplanes through the origin.*

We can actually construct these fundamental regions [8]. If B is a finite subgroup of $GL_n(\mathbb{R})$, then B is conjugate to a finite subgroup of the orthogonal group $O(n)$. Let $g \in GL_n(\mathbb{R})$ and $K \subset O(n)$ such that $B = gKg^{-1}$. Since $O(n)$ fixes the sphere, the orbit of $\alpha \in S^{n-1}$, $\text{orb}(\alpha) = \{\alpha k : k \in K\}$, is contained in the sphere. Choose α such that $|\text{orb}(\alpha)| = |K| = |B| = m$. Construct a Voronoi diagram on S^{n-1} for the set $\text{orb}(\alpha)$. Then the Voronoi cell containing α (or any element of $\text{orb}(\alpha)$) is defined by hyperplanes through the origin, $\{H_j\}_{j=1}^m$. The cone defined by these hyperplanes is a fundamental region for K . Since g is a linear transformation, then $\{H_j g^{-1}\}_{j=1}^m$ are hyperplanes through the origin and bound a fundamental region for B .

Theorem 5. *Suppose B is a finite subgroup of $GL_n(\mathbb{R})$ and $\Gamma = c\mathbb{Z}^n$ is such that Γ^* has at least one basis element in the interior of a fundamental region for B . Then Γ is B -admissible.*

Define the ϵ -neighborhood of η as $N_\epsilon(\eta) = \{\xi : |\xi - \eta| < \epsilon\}$. We rely on the following easily verifiable lemmas:

Lemma 6. *Let F be a region bounded by hyperplanes through the origin. Let v be a vector contained in the interior of F . Let K be any compact set. Then there exists $m \in \mathbb{Z}$ such that $K + mv \subset F$.*

Lemma 7. *Let G be any group and suppose R is a G -tiling set for a set V with $R = Q_1 \cup Q_2$, $Q_1 \cap Q_2 = \emptyset$. If $R' = Q_1 \cup Q_2 g$ for some $g \in G$, then R' is a G -tiling set for V .*

Lemma 8. *Suppose F is a fundamental region for a finite group B . Then $F \setminus (F + v)$ is starlike with respect to the origin for any vector v in F .*

Lemma 9. Suppose F is a fundamental region for a finite group B and R is a set such that $R \subset F$ and $N_\epsilon(0) \cap F \subset R$ for some $\epsilon > 0$. Let $S = \bigcup_{b \in B} Rb$. Then

- (i) There exists $\alpha > 0$ such that $N_\alpha(0) \subset S$
- (ii) if R is starlike with respect to the origin, then S is starlike with respect to the origin.

Proof of Theorem 5. Choose F , a fundamental region for B bounded by hyperplanes through the origin. Let $\{\gamma_i\}_{i=1}^n$ be a basis for Γ^* ordered so that γ_n is in the interior of F .

Let $P = \{\sum_{i=1}^n t_i \gamma_i : t_i \in [-\frac{1}{2}, \frac{1}{2}]; i = 1, \dots, n\}$, a Γ^* -tiling set for $\hat{\mathbb{R}}^n$. Since P is compact and γ_n is in the interior of F , Lemma 6 provides a smallest integer m such that $P + m\gamma_n \subset F$. Define $A_0 = P \cap F$ and for $j = 1, \dots, m$, iteratively define

$$A_j = [\{(P \setminus \bigcup_{k=0}^{j-1} A_k) + j\gamma_n\} \cap F] - j\gamma_n. \quad (2)$$

Then $A_{j_1} \cap A_{j_2} = \emptyset$ for all $j_1 \neq j_2$ and $P = \bigcup_{j=0}^m A_j$. Define

$$R = \bigcup_{j=0}^m (A_j + j\gamma_n). \quad (3)$$

Then, by multiple applications of Lemma 7, R is a Γ^* -tiling set for $\hat{\mathbb{R}}^n$.

For $0 < \epsilon \leq \min\{|\frac{1}{2}\gamma_i|\}_{i=1}^n$, $N_\epsilon(0) \subset P$. Since $A_0 = P \cap F$, then $N_\epsilon(0) \cap F \subset A_0 \subset R$.

Since $\bigcup_{j=0}^m (P + j\gamma_n)$ is a convex set containing the origin, it is obviously starlike with respect to the origin. Then, using Lemma 8 and the definition of A_0 ,

$$\left(\left[\bigcup_{j=0}^m (P + j\gamma_n) \right] \cap [F \setminus (F + \gamma_n)] \right) \cup A_0 \quad (4)$$

is starlike with respect to the origin.

By establishing mutual containment between (3) and (4), we see that R satisfies the hypotheses of Lemma 9 (i) and (ii). Therefore, R is B -tiling set for a starlike neighborhood of the origin. Hence, Γ satisfies Definition 5. \square

Example 3. We look at an example in $\hat{\mathbb{R}}^2$. Let $B = D_4$ and $\Gamma = \begin{pmatrix} 1 & 0 \\ -2 & 2 \end{pmatrix} \mathbb{Z}^2$. Figures 3 and 4 show how we divide P into the sets A_j defined by (2).

Figure 4 shows how we build R as a union of translations of the sets A_j . In this figure, we can also see that R is the intersection of the set $F \setminus (F + \gamma_n)$ with a union of translates of the parallelogram P . In Figure 4, $R = \bigcup_{j=0}^2 (A_j + j\gamma_2) = \left[\bigcup_{j=0}^2 (P + j\gamma_2) \right] \cap [F \setminus (F + \gamma_2)]$.

Figure 5 depicts the sets R and S establishing the D_4 -admissibility of Γ .

The simplest situation is when the chosen dual lattice, Γ^* , has basis vectors that each lie in the one-dimensional faces of the boundary of the fundamental region. More formally:

Definition 6. Let B be a finite subgroup of $GL_n(\mathbb{R})$ and fix F , a fundamental region for B bounded by n hyperplanes through the origin, $\{H_j\}_{j=1}^n$. A lattice Γ^* is *directly associated*

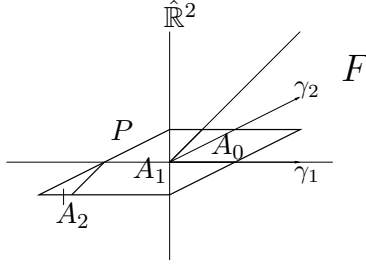

Figure 3: $P = \bigcup_{j=0}^2 A_j = A_0 \cup A_1 \cup A_2$.

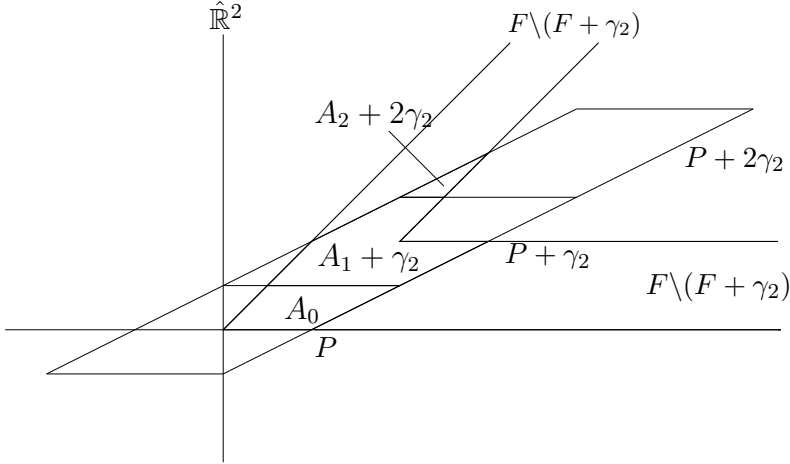

Figure 4: $R = A_0 \cup (A_1 + \gamma_2) \cup (A_2 + 2\gamma_2) = \left[\bigcup_{j=0}^2 (P + j\gamma_2) \right] \cap [F \setminus (F + \gamma_2)]$.

with (B, F) if there exists a basis of Γ^* , $\{\gamma_i\}_{i=1}^n$, such that every basis vector lies in the intersection of a distinct subset of size $n - 1$ of the set $\{H_j\}_{j=1}^n$; i.e. $\gamma_i \in \bigcap_{i \neq j=1}^n H_j$.

Since $\gamma_k \in H_i$ for every $k \neq i$ and $\{\gamma_i\}_{i=1}^n$ is a basis for $\Gamma^* = \hat{\mathbb{Z}}^n c^{-1}$, then $H_i = \text{span}\{\gamma_k : k \neq i\}$. One can check that $R = \{\sum_{i=1}^n t_i \gamma_i : t_i \in [0, 1]\}$ is starlike with respect to the origin and for any $\epsilon \leq \min\{|\gamma_i| : i = 1, \dots, n\}$, $N_\epsilon(0) \cap F \subset R$. This provides everything needed to prove the following proposition.

Proposition 10. *Suppose B is a finite subgroup of $GL_n(\mathbb{R})$ and F is a fundamental region for B . Suppose $\Gamma = c\mathbb{Z}^n$ is such that Γ^* is directly associated with (B, F) . Then Γ is B -admissible.*

Next we complete the proof of Theorem 3 by showing that $a = 2I_n$ is (B, Γ) -admissible when B is a finite group acting on \mathbb{R}^n and Γ is B -admissible.

Theorem 11. *If B is a finite subgroup of $GL_n(\mathbb{R})$ and Γ is almost any full rank lattice, then $a = 2I_n$ is (B, Γ) -admissible.*

Proof. Let $\{\gamma_i\}_{i=1}^n$ be a basis for Γ^* ordered such that γ_n is in the interior of F , a fundamental region for B . Construct the set R according to Theorem 5. Define a set of hyperplanes,

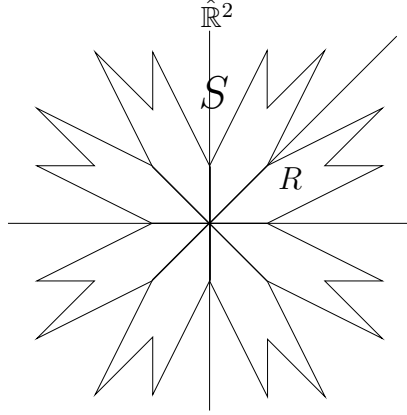

Figure 5: $S = \bigcup_{b \in B} Rb$.

each formed by the span of all but one of the lattice basis vectors:

$$K_i = \text{span} \{ \gamma_j : j \neq i, j = 1, \dots, n \} \text{ for } 1 \leq i \leq n-1. \quad (5)$$

Let $\{H_i\}_{i=1}^n$ be the set of hyperplanes bounding F . (If the fundamental regions for B are bounded by $m < n$ hyperplanes through the origin, then B is acting on \mathbb{R}^m . For simplicity, we assume F is bounded by n hyperplanes.) Let H be the subset of the union of the hyperplanes H_i that forms the boundary of F . Then, from the construction of R , we see that R is bounded by H , $H + \gamma_n$, and the hyperplanes $\{K_i \pm \frac{1}{2}\gamma_i\}_{i=1}^{n-1}$.

Let V denote the set of all $1 \times (n-1)$ vectors with entries from $\{-1, 1\}$. We divide R in 2^{n-1} subsets of equal measure by defining R_v to be the region bounded by H , $H + \gamma_n$, and the hyperplanes $\{K_i\}_{i=1}^{n-1}$ and $\{K_i + v_i \frac{1}{2}\gamma_i\}_{i=1}^{n-1}$ for $v = (v_1, v_2, \dots, v_{n-1}) \in V$. The sets R_v are parallelepipeds whose union form R : $R = \bigcup_{v \in V} R_v$.

For each $v \in V$, $R_v a$ will be a parallelepiped whose measure is 2^n times the measure of R_v . Consequently, we can realize $R_v a$ as the union of 2^n translated copies of R_v . We enumerate these sets by vectors describing the translation identifying the set.

Let W be the set of all $1 \times n$ vectors with entries from $\{0, 1\}$. Fix $v \in V$. Define $h_{v(i)} \in H$ as the unique vector of minimal length emanating from the origin and terminating at the subspace $H \cap \{K_i + v_i \frac{1}{2}\gamma_i\}$.

Now we define the regions R_{vw} :

$$R_{vw} = R_v + \sum_{i=1}^{n-1} w_i h_{v(i)} + w_n \gamma_n. \quad (6)$$

We can reconstruct the sets $R_v(2I_n)$ and $R(2I_n)$ in the following manner

$$R_v(2I_n) = \bigcup_{w \in W} R_{vw} \quad (7)$$

$$R(2I_n) = \bigcup_{v \in V} R_v(2I_n) = \bigcup_{v \in V} \bigcup_{w \in W} R_{vw} \quad (8)$$

We complete the proof with three lemmas showing that the sets in the collection $\{\bigcup_{v \in V} R_{vw} : w \in W \setminus (0, \dots, 0)\}$ satisfy (i) and (ii) in Definition 5.

Lemma 12. For a fixed $w \in W$, $\mathfrak{m}(\bigcup_{v \in V} R_{vw}) = \mathfrak{m}(P)$ where \mathfrak{m} is Lebesgue measure.

Proof of Lemma 12. For each $v \in V$, R_{vw} is a parallelepiped, and we compute its measure by taking the products of the distances between its bounding hyperplanes in the directions of the basis vectors $\{\gamma_i\}_{i=1}^n$. Since $|\{H + w_n\gamma_n\} - \{H + (w_n + 1)\gamma_n\}| = |\gamma_n|$, then for each $v \in V$

$$\begin{aligned} \mathfrak{m}(R_{vw}) &= |\gamma_n| \prod_{i=1}^{n-1} \left| \left\{ K_i + w_i v_i \frac{1}{2} \gamma_i \right\} - \left\{ K_i + v_i (w_i + 1) \frac{1}{2} \gamma_i \right\} \right| \\ &= \frac{1}{2^{n-1}} \prod_{i=1}^n |\gamma_i| = \frac{1}{2^{n-1}} \mathfrak{m}(P). \end{aligned}$$

By definition $R_{uw} \cap R_{vw} = \emptyset$ for $u \neq v \in V$. Therefore

$$\mathfrak{m} \left(\bigcup_{v \in V} R_{vw} \right) = \sum_{v \in V} \mathfrak{m}(R_{vw}) = \sum_{v \in V} \frac{1}{2^{n-1}} \mathfrak{m}(P) = \mathfrak{m}(P) \quad (9)$$

with the last equality due to $|V| = 2^{n-1}$. Equation (9) verifies Lemma 12. \diamond

Lemma 13. Fix $w \in W$ and let $0 \neq \gamma \in \Gamma$. Then for any $u, v \in V$, $(R_{uw} + \gamma) \cap R_{vw} = \emptyset$.

Proof of Lemma 13. Let $\gamma \in \Gamma$. Then there exist $l_1, \dots, l_n \in \mathbb{Z}$ such that $\gamma = \sum_{i=1}^n l_i \gamma_i$. The set R_{vw} is bounded by the hyperplanes $H + w_n \gamma_n$, and $H + (w_n + 1)\gamma_n$, $\{K_i + v_i w_i \frac{1}{2} \gamma_i\}_{i=1}^{n-1}$, and $\{K_i + v_i (w_i + 1) \frac{1}{2} \gamma_i\}_{i=1}^{n-1}$. Then $R_{uw} + \gamma$ is bounded by the hyperplanes $H + (l_n + w_n)\gamma_n$, $H + (l_n + w_n + 1)\gamma_n$, $\{K_i + (l_i + u_i w_i \frac{1}{2}) \gamma_i\}_{i=1}^{n-1}$, and $\{K_i + [l_i + u_i (w_i + 1) \frac{1}{2}] \gamma_i\}_{i=1}^{n-1}$.

If $\xi \in (R_{uw} + \gamma) \cap R_{vw}$, then for each $j = 1, \dots, n-1$, ξ must be in the region

$$\left\{ K_j + \left[l_j + u_j (w_j + t) \frac{1}{2} \right] \gamma_j : t \in [0, 1] \right\} \cap \left\{ K_j + v_j (w_j + t) \frac{1}{2} \gamma_j : t \in [0, 1] \right\}.$$

So there must exist $s, \tilde{s} \in [0, 1]$ such that $\xi \in K_j + [l_j + u_j (w_j + s) \frac{1}{2}] \gamma_j$ and simultaneously $\xi \in K_j + v_j (w_j + \tilde{s}) \frac{1}{2} \gamma_j$. Then $l_j + u_j (w_j + s) \frac{1}{2} = v_j (w_j + \tilde{s}) \frac{1}{2}$.

Without loss of generality, we assume $v_j = 1$. If $u_j = v_j$ then $l_j + (w_j + s) \frac{1}{2} = (w_j + \tilde{s}) \frac{1}{2}$ or $l_j = \frac{1}{2}(\tilde{s} - s)$. Since $0 \leq s, \tilde{s} \leq 1$, then $-\frac{1}{2} \leq l_j \leq \frac{1}{2}$. With $l_j \in \mathbb{Z}$ we have $l_j = 0$. Therefore, γ does not translate in the direction of γ_j .

Now suppose $u_j \neq v_j$. Then $u_j = -v_j = -1$. So $l_j - (w_j + s) \frac{1}{2} = (w_j + \tilde{s}) \frac{1}{2}$. Then $l_j - w_j = \frac{1}{2}(\tilde{s} + s)$. Since $l_j \in \mathbb{Z}$ and $w_j \in \{0, 1\}$, then $l_j - w_j \in \mathbb{Z}$. However, with $0 \leq s, \tilde{s} \leq 1$, then $0 \leq \frac{1}{2}(\tilde{s} + s) \leq 1$. Thus, $l_j - w_j \in \{0, 1\}$. If $l_j - w_j = 0$, then $s = \tilde{s} = 0$. If $l_j - w_j = 1$, then $s = \tilde{s} = 1$. When $s, \tilde{s} \in \{0, 1\}$, then ξ must lie in a bounding hyperplane.

Finally, $\xi \in \{H + (l_n + w_n + t)\gamma_n : t \in [0, 1]\} \cap \{H + (w_n + t)\gamma_n : t \in [0, 1]\}$. So there must exist $s, \tilde{s} \in [0, 1]$ such that $\xi \in H + (l_n + w_n + s)\gamma_n$ and $\xi \in H + (w_n + \tilde{s})\gamma_n$. Thus, $l_n = \tilde{s} - s \in \mathbb{Z}$. Since $0 \leq s, \tilde{s} \leq 1$, then $\tilde{s} - s \in \{-1, 0, 1\}$. In the cases $l_n \in \{-1, 1\}$, both s and \tilde{s} must be integers. Hence, ξ must lie in a bounding hyperplane. The remaining case is where $l_n = 0$; here, there is no translation in the direction of γ_n .

Hence, if $\xi \in (R_{uw} + \gamma) \cap R_{vw}$ and $u = v$, then $\gamma = 0$. If $\xi \in (R_{uw} + \gamma) \cap R_{vw}$ and $u \neq v$, then ξ must lie only in bounding hyperplanes. Therefore for any $u, v \in V$ and $0 \neq \gamma \in \Gamma$, $(R_{uw} + \gamma) \cap R_{vw} = \emptyset$. \diamond

Define $S = \bigcup_{b \in B} Rb = \bigcup_{b \in B} \left(\bigcup_{v \in V} R_{v, (0, \dots, 0)} \right) b$ as in the proof of Theorem 5.

Lemma 14. $\bigcup_{\substack{w \in W \\ w \neq (0, \dots, 0)}} \bigcup_{v \in V} R_{vw}$ is a B -tiling set of $S(2I_n) \setminus S$.

Proof of Lemma 14.

$$S(2I_n) = \left(\bigcup_{b \in B} Rb \right) (2I_n) = \bigcup_{b \in B} R(2I_n)b \quad (10)$$

Therefore, using equations (8) and (10) we get

$$S(2I_n) \setminus S = \bigcup_{b \in B} \left(\bigcup_{\substack{w \in W \\ w \neq (0, \dots, 0)}} \bigcup_{v \in V} R_{vw} \right) b \quad (11)$$

Equation (11) establishes Lemma 14. \diamond

Lemmas 12, 13, and 14 verify that the collection of sets $\{ \bigcup_{v \in V} R_{vw} : w \in W \setminus (0, \dots, 0) \}$ satisfies (i) and (ii) from Definition 5. Therefore, $a = 2I_n$ is (B, Γ) -admissible.

When Γ^* is directly associated to (B, F) , R is the parallelepiped defined by the basis vectors of Γ^* . This simplifies the proof as $K_i = H_i$ is a hyperplane bounding R (although we must also define K_n). This is a specific case of the preceding argument. \square

Proof of Theorems 1 and 3: For any finite group B acting on \mathbb{R}^n , almost any full rank lattice Γ , and $a = 2I_n$, Theorem 5 (or Proposition 10), Theorem 11, and Theorem 2 prove Theorem 3 and therefore Theorem 1. \square

The supports sets constructed in the proof of Theorem 3 were formed by subtracting the vector $\sum_{i=1}^n \frac{1}{2} \gamma_i$ from the parallelepiped, \tilde{P} , defined by the basis of Γ^* . More generally, we could have subtracted any vector $\alpha = (\alpha_1, \dots, \alpha_n) \in \hat{\mathbb{R}}^n$ such that $\tilde{P} - \sum_{i=1}^n \alpha_i \gamma_i$ contains an open neighborhood of the origin.

Example 4. Expanding on Example 3, let $B = D_4$, $\Gamma = \begin{pmatrix} 1 & 0 \\ -2 & 2 \end{pmatrix} \mathbb{Z}^2$, and $a = 2I_n$. In dimension two, $V = \{-1, 1\}$ and $W = \{(0, 0), (1, 0), (0, 1), (1, 1)\}$. Figure 6 shows the regions R and R_v along with the hyperplanes K_1 and $K_1 \pm \frac{1}{2} \gamma_1$.

Figure 7 shows that $R(2I_n) = \bigcup_{v \in V} \bigcup_{w \in W} R_{vw}$. The vectors $h_{-1(1)} = h_{-1}$ and $h_{1(1)} = h_1$ are also shown.

In Figure 7, we invoke Theorem 2 to produce the composite dilation wavelet $\Psi = (\psi^1, \psi^2, \psi^3)$. Observe that these generating functions, ψ^1, ψ^2, ψ^3 , are defined by

$$\hat{\psi}^1 = \sqrt{2} \chi_{[R_{-1, (1, 0)} \cup R_{1, (1, 0)}]}, \quad \hat{\psi}^2 = \sqrt{2} \chi_{[R_{-1, (0, 1)} \cup R_{1, (0, 1)}]}, \quad \hat{\psi}^3 = \sqrt{2} \chi_{[R_{-1, (1, 1)} \cup R_{1, (1, 1)}]}.$$

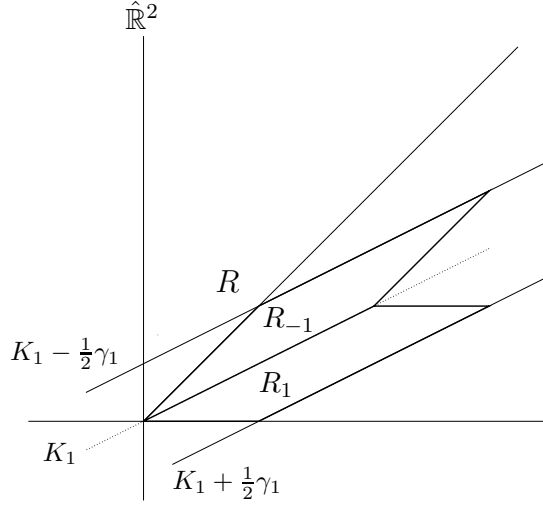

Figure 6: $R = R_{-1} \cup R_1$.

3 Singly Generated, MSF, Composite Dilation Wavelets

Guo et al. [13] show that in the case of MRA composite dilation wavelets the number of wavelet generating functions is determined by the expanding matrix. In Definition 1, this corresponds to $L = |\det(a)| - 1$ when a has an integer determinant. In Section 2.2 we have shown the existence of composite dilation wavelets with $2^n - 1$ wavelet generators. This section provides MSF composite dilation wavelets with a single wavelet generating function.

3.1 Singly Generated MRA, MSF, Composite Dilation Wavelets for $L^2(\mathbb{R}^n)$

Here we select B , Γ , and a in order to construct a singly generated MRA, MSF, composite dilation wavelet system for $L^2(\mathbb{R}^n)$. We surrender the freedom of the previous section.

Theorem 15. *There exists a singly generated, MRA, MSF, composite dilation wavelet for $L^2(\mathbb{R}^n)$.*

Proof. Choose $\Gamma = \mathbb{Z}^n$ so $\Gamma^* = \hat{\mathbb{Z}}^n$ has the standard basis vectors $\{\hat{e}_i\}_{i=1}^n = \{e_i^t\}_{i=1}^n$. Define $H_i = \hat{e}_i^\perp$, the hyperplane perpendicular to \hat{e}_i . Let B be the group generated by reflections through H_i for every $i = 1, \dots, n$. When F is the positive span of $\{\hat{e}_i\}_{i=1}^n$, Γ^* is directly associated with (B, F) . Therefore, we define $R = \{\sum_{i=1}^n t_i \hat{e}_i : t_i \in [0, 1]\}$. Then R is clearly a $\hat{\mathbb{Z}}^n$ tiling set for $\hat{\mathbb{R}}^n$. Define $S = \bigcup_{b \in B} Rb = \{\sum_{i=1}^n s_i \hat{e}_i : s_i \in [-1, 1]\}$. Then S is a starlike neighborhood of the origin and R is a B -tiling set for S . Therefore \mathbb{Z}^n is B -admissible.

Define a as the modified permutation matrix sending ξ_1 to ξ_n and ξ_i to ξ_{i-1} for $i =$

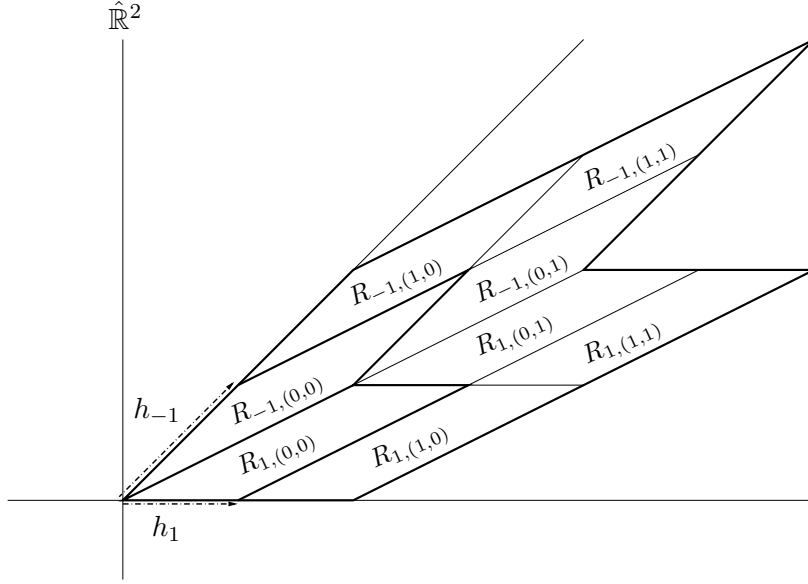

Figure 7: $R(2I_n) = \bigcup_{v \in V} \bigcup_{w \in W} R_{vw}$.

$2, \dots, n$ with the modification that it doubles ξ_2 . So

$$a = \begin{pmatrix} 0 & 0 & 0 & \cdots & 0 & 1 \\ 2 & 0 & 0 & \cdots & 0 & 0 \\ 0 & 1 & 0 & \cdots & 0 & 0 \\ 0 & 0 & 1 & \cdots & 0 & 0 \\ \vdots & \vdots & \vdots & \ddots & \vdots & \vdots \\ 0 & 0 & 0 & \cdots & 1 & 0 \end{pmatrix}$$

Then $|\det(a)| = 2$ and $a^n = 2I_n$. Thus, a is expanding.

Observe that

$$Ra = \left\{ t_1 \hat{e}_1 + \sum_{i=2}^n t_i \hat{e}_i : t_1 \in [0, 2], t_i \in [0, 1] \text{ for } i = 2, \dots, n \right\}$$

$$Sa = \left\{ s_1 \hat{e}_1 + \sum_{i=2}^n s_i \hat{e}_i : s_1 \in [-2, 2], s_i \in [-1, 1] \text{ for } i = 2, \dots, n \right\}.$$

Then $R \subset Ra$ and $S \subset Sa$. Define $R_1 = Ra \setminus R = R + \hat{e}_1$. By Lemma 7, R_1 is a $\hat{\mathbb{Z}}^n$ -tiling set for $\hat{\mathbb{R}}^n$. As B acts on R_1 we obtain $Sa \setminus S$:

$$\bigcup_{b \in B} R_1 b = Sa \setminus S. \quad (12)$$

By (12), R_1 is a B -tiling set for $Sa \setminus S$. Therefore, a is (B, \mathbb{Z}^n) -admissible.

From Theorem 2, with $\psi = \check{\chi}_{R_1}$, $\mathcal{A}_{AB\Gamma}(\psi)$ is an orthonormal basis for $L^2(\mathbb{R}^n)$. Therefore, ψ is an MRA, composite dilation wavelet for $L^2(\mathbb{R}^n)$. \square

Example 5. Remaining in $\hat{\mathbb{R}}^2$, let B be the group generated by the reflections through $\xi_1 = 0$ and $\xi_2 = 0$. Let $\Gamma = \mathbb{Z}^2$ and $a = \begin{pmatrix} 0 & 1 \\ 2 & 0 \end{pmatrix}$. Figure 8 shows the sets R, R_1, S , and Sa . We see that $S = \bigcup_{b \in B} Rb$ and $Sa \setminus S = \bigcup_{b \in B} R_1b$. In this case the composite dilation wavelet is the function ψ defined by $\hat{\psi} = \chi_{R_1}$. The associated composite dilation scaling function for the MRA is the function φ defined by $\hat{\varphi} = \chi_R$.

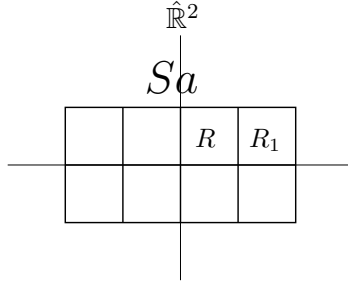

Figure 8: $S = \bigcup_{b \in B} Rb$ and $Sa \setminus S = \bigcup_{B \in b} R_1b$.

This demonstrates one of the potentially useful properties of composite dilation wavelets. Without the dilations by the group B , we could generate a wavelet system using $\tilde{a} = 2(I_n)$ and a unit square centered at the origin. In that case, we know the wavelet space would need $2^n - 1$ wavelet generators. However, the composite dilations allow us to transfer this need for generators into the group B . When the number of generators for B is considerably smaller than the determinant of the expanding matrix (in this section B has n generators while $|\det(\tilde{a})| = 2^n$) we are able to significantly reduce the input requirements for any implementation (in this section, from $2^n - 1$ to $n + 1$). Using composite dilations, an implementation would only require input of the n generators of the composite dilation group B and the single wavelet generator. It is plausible that implementation algorithms can exploit the group properties to take advantage of this fact.

3.2 Singly Generated Non-MRA, MSF, Composite Dilation Wavelets for $L^2(\mathbb{R}^n)$

In this section, we retain the freedom to choose an arbitrary finite group B by sacrificing the MRA structure. We do so by selecting a fundamental region F and a lattice Γ so that Γ^* is directly associated with (B, F) .

Theorem 16. *For any finite subgroup of $GL_n(\mathbb{R})$ there exists a singly generated non-MRA, MSF, composite dilation wavelet for $L^2(\mathbb{R}^n)$.*

Proof. Let B be a finite subgroup of $GL_n(\mathbb{R})$ and select F , a fundamental region for B . Choose $\Gamma = c\mathbb{Z}^n$ so that Γ^* is directly associated with (B, F) .

Define $R = \{\sum_{i=1}^n t_i \gamma_i : t_i \in [0, 1]\}$ and let $a = 2I_n$. To construct a set whose dilations by a are orthogonal to each other requires an iterative process. First apply a^{-1} to R . Then $R \cap Ra^{-1} = Ra^{-1} \neq \emptyset$. This nonempty intersection prevents the orthogonality of

the a dilations of R . Remove and translate this intersection, Ra^{-1} , by an element of Γ^* to maintain the Γ^* -tiling property. Then we obtain a new set, $R_1 = (R \setminus Ra^{-1}) \cup (Ra^{-1} + \gamma)$.

Now R_1 is again a Γ^* -tiling set for $\hat{\mathbb{R}}^n$, however, the a dilations of R_1 are not orthogonal. Repeat the process with R_1 to obtain R_2 and continue the iterative process to obtain R_k for any natural number k . Then define $R_\infty = \lim_{k \rightarrow \infty} R_k$. R_∞ is a Γ^* -tiling set of $\hat{\mathbb{R}}^n$ and has orthogonal a dilations. The union of the a dilates of R_∞ is F : $F = \bigcup_{j \in \mathbb{Z}} R_\infty a^j$.

F is a fundamental region for B so applying the dilations from B will give orthogonal sets filling $\hat{\mathbb{R}}^n$. As a commutes with any matrix, $\hat{\mathbb{R}}^n = \bigcup_{j \in \mathbb{Z}} \bigcup_{b \in B} Rba^j$. Since R_∞ is a Γ^* -tiling set, we establish an orthonormal basis for $L^2(\hat{\mathbb{R}}^n)$ as in the previous proofs.

Let $\psi = |\det(c)|^{\frac{1}{2}} \tilde{\chi}_{R_\infty}$, then $\mathcal{A}_{AB\Gamma}(\psi)$ is an orthonormal basis for $L^2(\mathbb{R}^n)$. Therefore, ψ is a non-MRA, MSF, composite dilation wavelet. (It is non-MRA since there is no scaling function φ corresponding to ψ .) \square

Example 6. Let $a = 2(I_2)$ and $B = D_4$. Choose the full rank lattice, $\Gamma = \begin{pmatrix} 1 & 0 \\ -1 & 1 \end{pmatrix} \mathbb{Z}^2$, so that Γ^* is directly associated with (B, F) . Figure 9 depicts the set R_∞ when we take $\gamma = \gamma_2$ or $\gamma = \gamma_1 + \gamma_2$. It is apparent in each figure how the sets R_k are formed. In both cases, the wavelet ψ is defined by $\hat{\psi} = \chi_{R_\infty}$.

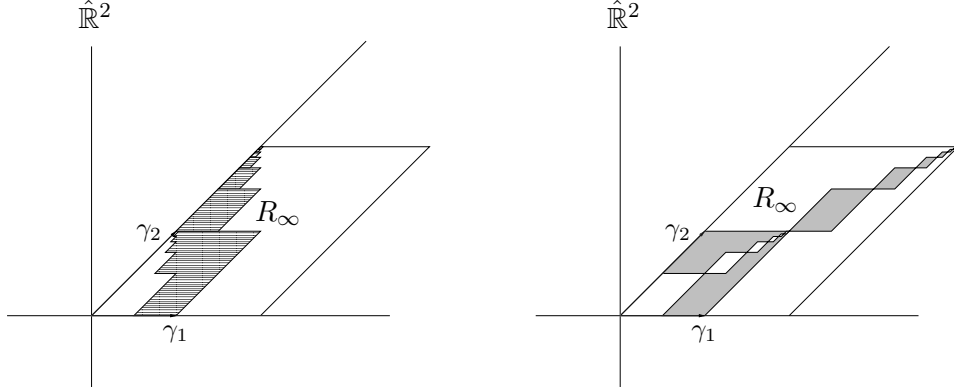

Figure 9: $R_\infty = \lim_{k \rightarrow \infty} R_k$ for $\gamma = \gamma_2$ (left) and $\gamma = \gamma_1 + \gamma_2$ (right).

3.3 Singly generated, MRA, MSF, Composite Dilation Wavelets for $L^2(\mathbb{R}^2)$

The two previous subsections dealt with singly generated composite dilation wavelets for $L^2(\mathbb{R}^n)$. Letting the dimension be arbitrary forced us to give something up. In dimension two, we maintain the MRA structure and the freedom in choosing our group B .

Theorem 17. *If B is a finite Coxeter group acting on \mathbb{R}^2 , there exists a singly generated, MRA, MSF composite dilation wavelet for $L^2(\mathbb{R}^2)$.*

Proof. Let B be generated by reflections through two lines through the origin. Define b_j as the reflection through the lines l_j , $j = 1, 2$, bounding a fundamental region for B . The angle between l_1 and l_2 is $\frac{\pi}{m}$ where $m \in \mathbb{Z}$ is the order of the rotation $b_1 b_2$.

Choose $\Gamma = c\mathbb{Z}^n$ so the basis vectors for Γ^* , $\{\gamma_1, \gamma_2\}$, lie in l_1 and l_2 , respectively, and $|\gamma_1| = 1, |\gamma_2| = \sqrt{2}$. Let $R = \{t_1\gamma_1 + t_2\gamma_2 : t_1, t_2 \in [0, 1]\}$ since Γ^* is directly associated with (B, F) . By Theorem 10, Γ is B -admissible with $S = \bigcup_{b \in B} Rb$ a starlike neighborhood of the origin.

Let $\rho(\frac{\pi}{m})$ denote the counter-clockwise rotation by $\frac{\pi}{m}$. Define $a = \sqrt{2}\rho(\frac{\pi}{m})$. Then a is an expanding matrix and $\gamma_1 a = \gamma_2, \gamma_2 a = (2\gamma_1)b_2$. Since $\gamma_2 b_2 = \gamma_2$, we have

$$\begin{aligned} Ra &= \{t_1\gamma_1 a + t_2\gamma_2 a : t_1, t_2 \in [0, 1]\} \\ &= \{t_1\gamma_2 + 2t_2\gamma_1 b_2 : t_1, t_2 \in [0, 1]\} = Rb_2 \cup (Rb_2 + \gamma_1 b_2) \end{aligned} \quad (13)$$

Applying b_2 to (13) we have $Rab_2 = R \cup (R + \gamma_1)$. When B acts on Ra we obtain:

$$\bigcup_{b \in B} Rab = \bigcup_{b \in B} Rab_2 b = \bigcup_{b \in B} [R \cup (R + \gamma_1)] b = S \cup \left[\bigcup_{b \in B} (R + \gamma_1) b \right]. \quad (14)$$

In \mathbb{R}^2 , all rotations commute and have a commuting relationship with the reflections b_j : $\rho(\theta)b_j = b_j\rho(-\theta)$ for $j = 1, 2$. Then $ab_1b_2a^{-1} = b_1b_2 = \rho(\frac{2\pi}{m})$ and $ab_2a^{-1} = b_1$. Since B can be generated by one reflection b_j and the rotation b_1b_2 , we have $aB = Ba$. Hence

$$Sa = \left(\bigcup_{b \in B} Rb \right) a = \bigcup_{b \in B} Rba = \bigcup_{b \in B} Rab. \quad (15)$$

Thus, combining (14) and (15) and defining $R_1 = R + \gamma_1$, we observe that $S \subset Sa$ and

$$Sa \setminus S = \bigcup_{b \in B} R_1 b. \quad (16)$$

Lemma 7 and (16) establish that R_1 is a Γ^* -tiling set for $\hat{\mathbb{R}}^n$ and a B -tiling set for $Sa \setminus S$. Therefore, a is (B, Γ) -admissible. By Theorem 2, for $\psi = |\det(c)|^{\frac{1}{2}} \check{\chi}_{R_1}$, we have $\mathcal{A}_{AB\Gamma}(\psi)$ is an orthonormal basis for $L^2(\mathbb{R}^n)$, and ψ is a singly generated, MRA, MSF, composite dilation wavelet for $L^2(\mathbb{R}^2)$. \square

Example 7. Let B be the group generated by b_1 and b_2 , the reflections through $\xi_2 = 0$ and $\xi_2 = \xi_1$, respectively. Choose $\Gamma = \begin{pmatrix} 1 & 0 \\ -1 & 1 \end{pmatrix} \mathbb{Z}^2$ and $a = \begin{pmatrix} 1 & 1 \\ -1 & 1 \end{pmatrix} = \sqrt{2}\rho(\frac{\pi}{4})$. Figure 10 depicts $Rab_2 = R \cup (R + \gamma_1)$.

The left hand portion of Figure 11 depicts the sets $Sa, Sa \setminus S, S, R$, and R_1 . Let $\hat{\varphi} = \chi_R$ and $\hat{\psi} = \chi_{R_1}$.

The usefulness of Coxeter groups in the development of orthonormal bases and wavelets has a well-established history; for example, see the works of Geronimo, Hardin, Kessler, and Mossapust including [7], [14], and [19]. For more information on Coxeter groups see [4], [5], and [8].

By interchanging the roles of reflections and rotations between a and B , we may also obtain a singly generated, MRA, MSF composite dilation wavelet with rotation groups. A similar proof to the proof of Theorem 17 provides the following theorem:

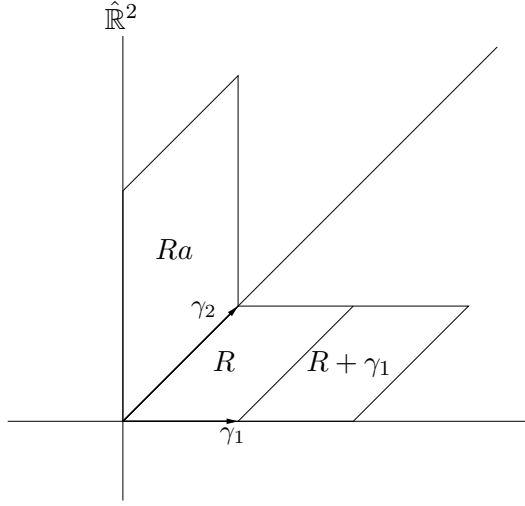

Figure 10: $Rab_2 = R \cup (R + \gamma_1)$.

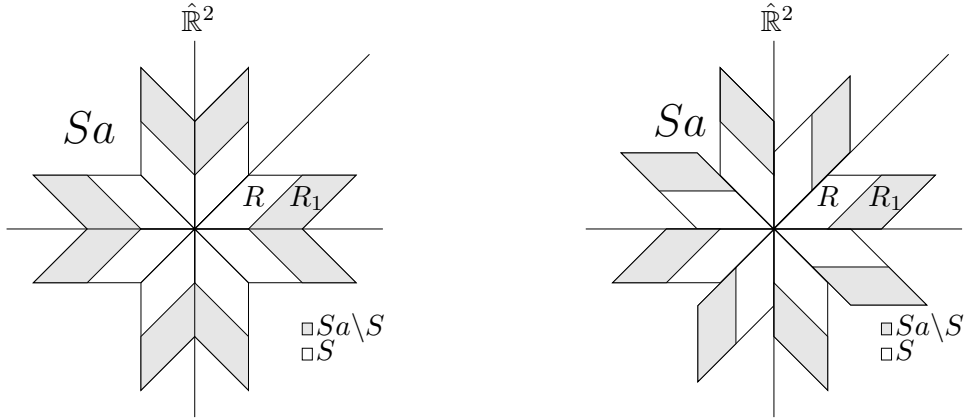

Figure 11: R is a B -tiling set for S . R_1 is a B -tiling set for $Sa \setminus S$.

Theorem 18. *If B is a finite rotation group acting on \mathbb{R}^2 , there exists a singly generated, MSF, MRA composite dilation wavelet for $L^2(\mathbb{R}^2)$.*

Example 8. The right hand portion of Figure 11 depicts the sets Sa , $Sa \setminus S$, S , R , and R_1 for an example related to Theorem 18. In this case, B is the group generated by the rotation $\rho(\frac{\pi}{4})$ and $a = \sqrt{2} \begin{pmatrix} 0 & 1 \\ 1 & 0 \end{pmatrix}$ is an expanding reflection through the line $\xi_2 = \xi_1$. Again, $\hat{\varphi} = \chi_R$ and $\hat{\psi} = \chi_{R_1}$.

4 Conclusion

To capture directional information, long, narrow windows in multiple directions have been utilized in [3], [6], [9], and more. From the constructive proofs leading to Theorem 3,

we can create windows as long and narrow as we wish with essentially any orientation. In $\widehat{\mathbb{R}}^2$, choose B generated by reflections through the line $\xi_2 = 0$ and the line $\xi_2 = \tan(\frac{\pi}{m})\xi_1$. Since Γ can be essentially arbitrary, we may choose Γ to create long, narrow Γ^* -tiling sets. We select m to obtain the desired orientations. Increasing the number of orientations requires only a change in the generators for B , not an increase in their number. Therefore, the necessary input for an implementation is independent of the desired number of orientations.

Example 9. Figure 12 depicts one possible set of three wavelet generating functions for dimension two when $m = 5$ (the dark sets). We then show the support sets for several of the B -dilates (but not all) and a few translates for one of these functions. Notice that we can capture directional information with these windows in $m = 5$ distinct orientations.

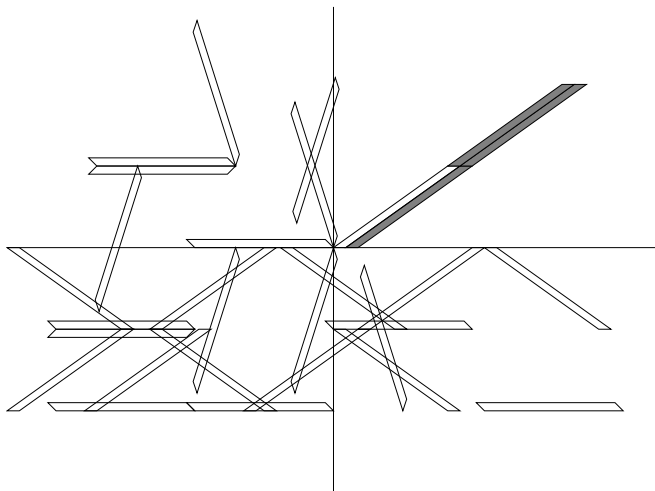

Figure 12: Some oriented windows in the Fourier domain for a group generated by reflections through the ξ_1 -axis and the line through the origin with slope $\tan(\frac{\pi}{5})$.

The obvious next step is to use the results of this paper to find composite dilation systems with improved time localization. As with shearlets, this will likely require the construction of Parseval frames by forming smoother generating functions supported on the sets constructed in Theorem 3.

Acknowledgments. The author was partially supported by a Department of Homeland Security Fellowship and by NSF (VIGRE) grant number 0602219. The author would like to thank Guido Weiss and Edward Wilson for their many rewarding conversations during this project and Alexi Savov whose senior honors thesis at Washington University was fundamental in developing this theory. The author thanks Daniel Allcock and Peter Trapa for pointing out Lemma 4. The author is also grateful for the useful comments from the anonymous referees.

References

- [1] J. D. Blanchard. Existence and accuracy results for composite dilation wavelets. *Ph.D. dissertation*, 2007. Washington University in St. Louis.
- [2] E. Candès and D. L. Donoho. Ridgelets: a key to higher-dimensional intermittency? *R. Soc. Lond. Philos. Trans. Ser. A Math. Phys. Eng. Sci.*, 357(1760):2495–2509, 1999.
- [3] E. Candès and D. L. Donoho. Curvelets and curvilinear integrals. *J. Approx. Theory*, 113(1):59–90, 2001.
- [4] H. S. M. Coxeter. *Regular polytopes*. Second edition. The Macmillan Co., New York, 1963.
- [5] H. S. M. Coxeter. *Regular complex polytopes*. Cambridge University Press, London, 1974.
- [6] M. N. Do and M. Vetterli. Contourlets. In *Beyond wavelets*, volume 10 of *Stud. Comput. Math.*, pages 83–105. Academic Press/Elsevier, San Diego, CA, 2003.
- [7] J. Geronimo, D. Hardin, and P. Massopust. An application of Coxeter groups to the construction of wavelet bases in \mathbf{R}^n . In *Fourier analysis (Orono, ME, 1992)*, volume 157 of *Lecture Notes in Pure and Appl. Math.*, pages 187–196. Dekker, New York, 1994.
- [8] L. C. Grove and C. T. Benson. *Finite reflection groups*, volume 99 of *Graduate Texts in Mathematics*. Springer-Verlag, New York, second edition, 1985.
- [9] K. Guo, G. Kutyniok, and D. Labate. Sparse multidimensional representations using anisotropic dilation and shear operators. In *Wavelets and splines: Athens 2005*, Mod. Methods Math., pages 189–201. Nashboro Press, Brentwood, TN, 2006.
- [10] K. Guo and D. Labate. Optimally sparse multidimensional representation using shear-lets. *SIAM J. Math. Anal.*, 2006. submitted.
- [11] K. Guo, D. Labate, W. Lim, G. Weiss, and E. N. Wilson. Wavelets with composite dilations. *Electron. Res. Announc. Amer. Math. Soc.*, 10:78–87, 2004.
- [12] K. Guo, D. Labate, W. Lim, G. Weiss, and E. N. Wilson. The theory of wavelets with composite dilations. In *Harmonic analysis and applications*, Appl. Numer. Harmon. Anal., pages 231–250. Birkhäuser Boston, Boston, MA, 2006.
- [13] K. Guo, D. Labate, W. Lim, G. Weiss, and E. N. Wilson. Wavelets with composite dilations and their MRA properties. *Appl. Comput. Harmon. Anal.*, 20(2):202–236, 2006.
- [14] D. Hardin, B. Kessler, and P. Massopust. Multiresolution analyses based on fractal functions. *J. Approx. Theory*, 71(1):104–120, 1992.
- [15] E. Hernández and G. Weiss. *A first course on wavelets*. Studies in Advanced Mathematics. CRC Press, Boca Raton, FL, 1996.

- [16] I. Krishtal, B. Robinson, G. Weiss, and E. N. Wilson. Some simple Haar-type wavelets in higher dimensions. *J. Geom. Anal.*, 17(1):87–96, 2007.
- [17] Demetrio Labate, Wang-Q Lim, Gitta Kutyniok, and Guido Weiss. Sparse multidimensional representation using shearlets. In *Wavelets XI (San Diego, CA, 2005)*, SPIE Proc. 5914, pages 254–262. SPIE, Bellingham, WA, 2005.
- [18] W. Lim. Wavelets with composite dilations and their applications. *Ph.D. dissertation*, 2006. Washington University in St. Louis.
- [19] P. Massopust. Fractal functions and wavelets: examples of multiscale theory. In *Abstract and applied analysis*, pages 225–247. World Sci. Publ., River Edge, NJ, 2004.
- [20] F. Meyer and R. Coifman. Brushlets: steerable wavelet packets. In *Beyond wavelets*, volume 10 of *Stud. Comput. Math.*, pages 61–82. Academic Press/Elsevier, San Diego, CA, 2003.
- [21] G. Weiss and E. N. Wilson. The mathematical theory of wavelets. In *Twentieth century harmonic analysis—a celebration (Il Ciocco, 2000)*, volume 33 of *NATO Sci. Ser. II Math. Phys. Chem.*, pages 329–366. Kluwer Acad. Publ., Dordrecht, 2001.